

# Skyline Banner Stand

With Graphic Exchange System

exhibiting solutions



# Big On Impact and Flexibility: Skyline Banner Stand

Make an impact anywhere you need a big graphic in a small space. Skyline's Banner Stand is lightweight, convenient and flexible to fit your changing needs.

## Easy to Change Graphics

Our unique exchange system allows you to update or change your graphic to target specific audiences.

## Available in Two Widths

Choose from our standard 34" unit or our wider 48" unit that can be used as a full banner stand, a tabletop display – or both.

## Carrying Case and Shipping Case

Our soft-sided carrying case has straps for easy transport and our telescoping case provides versatility and protection.

## Fulfills Multiple Needs

Banner stands are great for trade shows, events, retail areas, lobbies and more.

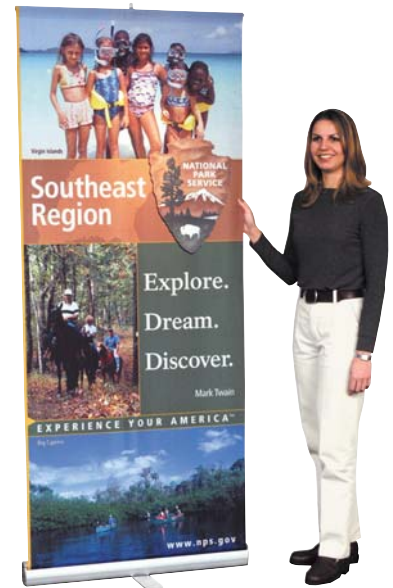

Skyline produces its graphics in-house for the best quality and fit – guaranteed.

## Unique Graphic Exchange System!



Lift the Exchange System up from base.



Slide one graphic off and the other on.



Lower the Exchange System back into base.

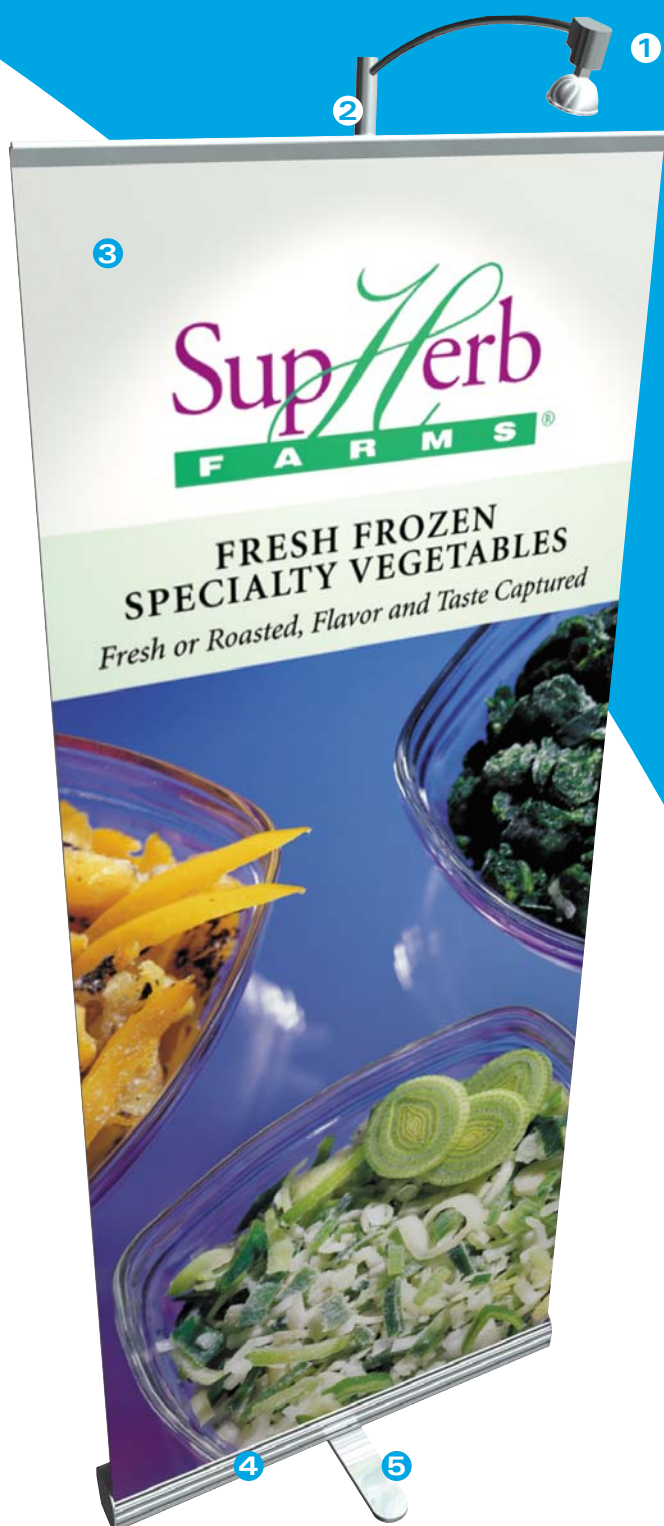

**1 Halogen Lighting - 50 Watt**  
Simply attaches to support pole and highlights your graphic.

**2 Graphic Support Pole**  
Sections are conveniently shock-corded for easy set up.

**3 Fabric or Laminated Graphic**  
Communicate your message in style with vibrant and durable fabric graphic or laminated print.

**4 Spring-Loaded Base**  
Protects your graphic during transportation and storage. The base also contains a **Graphic Exchange Strip** (below) which allows you to easily change your graphics on-site.



**5 Support Stand**  
Simply swivels open during use and back for streamlined packing.

## Banner Stand



Our 48" wide unit can be designed for use as a full banner stand and a tabletop.



Units can be used separately or joined to become an effective in-line exhibit at trade shows and events.



Multiple units ensure brand consistency throughout your network of dealers and associates.

## Specifications

### Wide

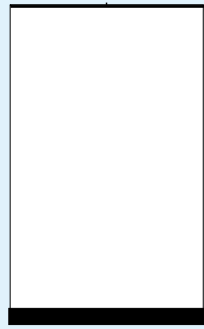

10.8 lbs. (4.9 kg)

### Standard

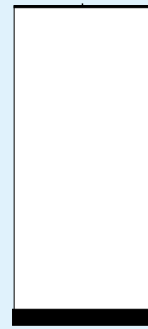

8.3 lbs. (3.8 kg)

### Single (Side view)

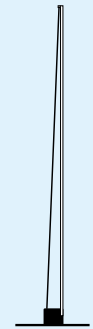

18" (45 cm)

### Double (Side view)

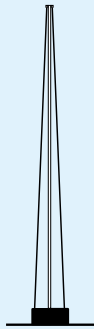

21.5" (55 cm)

13.2 lbs. (6.0 kg)

### Tabletop



9.7 lbs. (4.4 kg)

### Carrying Cases

Soft-sided case with strap

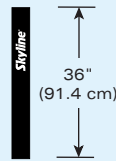

**Single Case**  
5" x 5"  
(12.7 x 12.7 cm)  
1.3 lbs. (.6 kg)

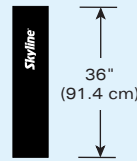

**Double Case**  
5" x 9"  
(12.7 x 22.9 cm)  
1.8 lbs. (.8 kg)

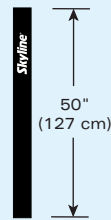

**Wide Case**  
5" x 5"  
(12.7 x 12.7 cm)  
1.7 lbs. (.8 kg)

### Telescoping Shipping Case

Adjustable Hard case

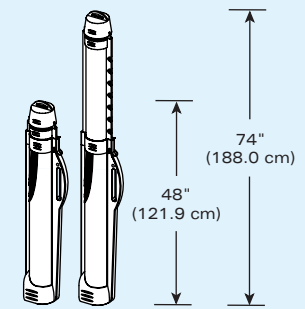

**Telescoping Case**  
5.75" x 9.5"  
(14.6 x 24.1 cm)  
6.2 lbs. (2.8 kg)